

Induction Units

for Installation in Access Floors



LTG Aktiengesellschaft

D - 70435 Stuttgart, Grenzstraße 7
☎ +49 (0711) 82 01-180, Fax +49 (0711) 82 01-720
Internet: <http://www.LTG-AG.de>
E-Mail: info@LTG-AG.de

LTG Incorporated

105 Corporate Drive, Suite E
Spartanburg S.C., 29303 USA
☎ +1 (864) 599-6340, Fax +1 (864) 599-6344
Internet: <http://www.LTG-INC.net>
E-Mail: info@LTG-INC.net

LTG S.r.l. con socio unico

Via G. Leopardi 10
I-20066 Melzo
☎ +39 (02) 9 55 05 35, Fax +39 (02) 9 55 08 28
Internet: <http://www.LTG-SRL.com>
E-Mail: ltg@ltsrl.191.it

Components for Room Air Technology

Germany

Central Office (Frankfurt)

Sales area:

PLZ 54, 55, 60, 63, 64, 66-69, 97
 Sontraer Str. 27
 D-60386 Frankfurt am Main
 ☎ (069) 94 20 19-14, Fax -10
 E-mail: Bergmann@LTG-AG.de

Central office (Herborn)

Sales area:

PLZ 30, 31, 34-38, 56, 57, 61, 65
 Sperberweg 16
 D-35745 Herborn
 Herr Hartmann
 ☎ (02772) 570-725, Fax -727
 E-mail: Hartmann@LTG-AG.de

Eastern office (Berlin)

Sales area:

PLZ 10-25, 29, 39
 Eisenhutweg 51a
 D-12487 Berlin
 Herr Linke
 ☎ (030) 63 22 87-74, Fax -75
 E-mail: Linke@LTG-AG.de

Eastern office (Chemnitz)

Sales area:

PLZ 01-09, 98, 99
 Johannes-Ebert-Straße 20
 D-09128 Chemnitz
 Herr Schenfeld
 ☎ (0371) 77118-01, Fax -02
 E-mail: Schenfeld@LTG-AG.de

Southern office

Sales area:

PLZ 70-79, 88, 89
 Grenzstraße 7
 D-70435 Stuttgart
 Herr Gau
 ☎ (0711) 8201-209, Fax -210
 E-mail: Gau@LTG-AG.de

Sales area:

PLZ 80-87, 90-96
 Klosterweg 15
 D-85356 Freising
 Herr Heller
 ☎ (089) 9588-91, Fax -92
 E-mail: Heller@LTG-AG.de

Western office

Sales area:

PLZ 26-28, 32, 33, 40-53, 58-59
 Baststraße 30
 D-46119 Oberhausen/Rheinl.
 Herr Perenz
 ☎ (0208) 30431-55, Fax -56
 E-mail: Perenz@LTG-AG.de

Austria

KTG Klimatechnische Gesellschaft mbH

Schubertstraße 13, A-2126 Ladendorf
 ☎ (02575) 21089, Fax (02575) 21022
 E-Mail: office@ktg-wien.com

Great Britain

MAP

Motorised Air Products Ltd.

Unit 5A, Sopwith Crescent
 Wickford Business Park Wickford
 GB-Essex SS11 8YU
 ☎ (01268) 57 44 42, Fax (01268) 57 44 43
 E-Mail: info@mapuk.com

Netherlands

Opticlima Systems

Leeuwerikstraat 110, NL-3853 AG Ermelo
 ☎ (0341) 493969, Fax (0341) 493931
 E-Mail: info@opticlimate.nl

Poland

HTK Went Sp.z.o.o.

ul. Chopina 13/3, PL-30047 Krakow
 ☎ (012) 632 31 32, Fax (012) 632 81 93
 E-Mail: info@htk-went.pl

Portugal

ArGelo S. A.

R. Luis Pastor de Macedo, Lote 28 B
 P-1750-158 Lisboa
 ☎ (21) 752 01 20, Fax (21) 752 01 29
 E-Mail: info@argelo.pt

Slovenia

Energop Plus

Koprska 108 d, SLO- 1000 Ljubljana
 ☎ (01) 200 73 67, Fax (01) 42 33 346
 E-Mail: info@energoplus.si

Switzerland

Laminair AG

Kirchbergstrasse 105
 Ch-3400 Burgdorf
 ☎ (034) 420 02-10, (034) 420 02-11
 E-Mail: info@laminair.ch

Turkey

Step Müh. Yapi Ltd.

Yali Yolu Sokak, Turanlı Apt. No: 24 D.1
 TR- 34744 Bostanci-Istanbul
 ☎ (0216) 445 2931, Fax (0216) 445 2505
 E-Mail: info@stepyapi.com.tr

The Program for Room Air Technology

Components

Air diffusers for walls, floors and ceilings · LTG System clean[®] · linear diffusers Coandatrol[®] · ceiling air diffusers Coadavent[®] · displacement diffusers · LTG chilling fans cool wave[®] · induction units Klimavent[®] · fan coil units Raumluft · ceiling fan coil units Ventotel[®] · facade fan coil units · airflow control units · labair[®] system

Engineering services

Technical services for investors, architects, engineers and plant builders during design, construction and operation of buildings. Reliable and precise data relating to the ventilation of air conditioning system are given already before realization of the project, determined by measurements, calculations, building simulations and experiments.

Components for Process Air Technology

Japan

Toho Engineering Co. Ltd.

14-11, Shimizu 3-Chome, Kita Ku
 Japan 462 Nagoya
 ☎ (052) 9 91-10 40, Fax (052) 9 14-98 22
 E-Mail: main@tohoeng.com

The Program for Process Air Technology

Components

Axial-flow, centrifugal and tangential fans · Collector system for: coarse and fine particle filtration, separating and compacting, compressing and humidifying.

Engineering services

Technical services for construction engineers and plant designers during development and operation of assembly groups, machines and plants.

Induction Units for Installation in Access Floors Type HFB-N, HFB

Application

The Induction Units Type HFB are 2-pipe or 4-pipe units for ventilating, heating and/or cooling occupied zones (perimeter zones) with varying loads and transient load changes.

The unit is ideal for installation in access floors with a recommended clearance of 200 to 300 mm.

Since all the components are below floor level the Induction Units HFB may also be used with full height facade glazing.



Induction Unit for installation in access floors, Type HFB-D (illustration unit open - special version with 2 sockets)

Mode of Operation

The primary air (processed fresh air from the main plant), is led through a detachable nozzle box with replaceable nozzles (only in case of plastic nozzles).

The primary air jets induce a larger secondary air flow of room air in which is drawn across a flat heat exchanger. After a 90° deflection, the mixed air flow is expelled into the room in a vertical direction close to the facade via a ventilation grille on the floor.

In summer, this supply air mixes with the heated room air in front of the facade, in winter with the descending cold air close to the window (mixed air flow close to the facade).

In the cooling mode, the supply air, having passed the mixing air zone, passes through the room in by displacement.

The unit may be used as an underfloor convector for heating the room whenever the ventilation or air conditioning plant is isolated.

Versions

The LTG induction unit for installation in access floors type HFB is available in two versions:

- HFB-Z

with two-row heat exchanger for high caloric output with high primary air volume

- HFB-D

with three-row heat exchanger for high caloric output with low primary air volume

Both versions are available in identical lengths and grille widths.

Advantages

• Flexible use

- Thanks to the modular design, the unit may be progressively converted according to user requirements from a pure floor convector for heating to mechanical ventilation to a 4-pipe induction unit including cooling.

• Low energy consumption

- Low air plant operating costs due to operation at low initial pressure.
- Large-surface heat exchanger ensures a high natural convection capacity in the heating mode.

• High comfort

- High comfort in the cooling mode thanks to a combined mixed air/displacement air flow.
- Excellent shielding of floor-to-ceiling glass surfaces during winter.

• Acoustics

- Very low sound power level.
- No cross-talk sound transmission into adjacent rooms via the access floor.

• Maintenance

- Easy maintenance and cleaning thanks to good access and doing without movable parts.

• Installation

- Separate installation of A/C unit, facade and double floor.
- Fast/Easy retrofitting and conversion due to modular design.



Induction Unit for installation in access floors, Type HFB with aluminium grille

Tolerances

- For the dimensions given in this brochure, the General Tolerances according to DIN 7168-sg apply. For the outlet grille, the Special Tolerances stated in the drawing apply.
- Straightness and Twist Tolerances according to DIN 17615 Part 3.

Finish

- The surface finish is designed to meet the requirements for applications in buildings - room climate according to DIN 1946 Part 2. Other requirements on request.

Induction Unit for Installation in Access Floors Type HFB-D Dimensions

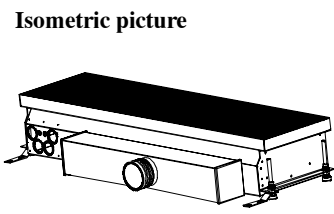
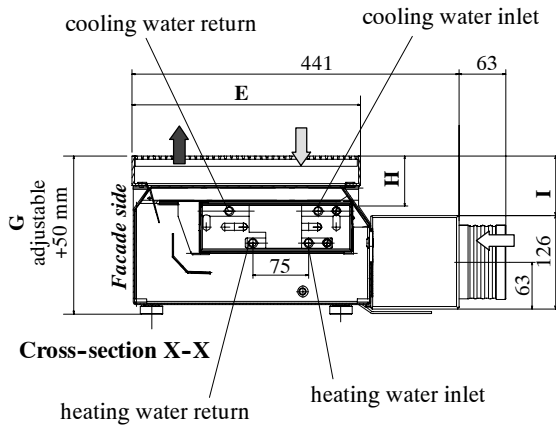
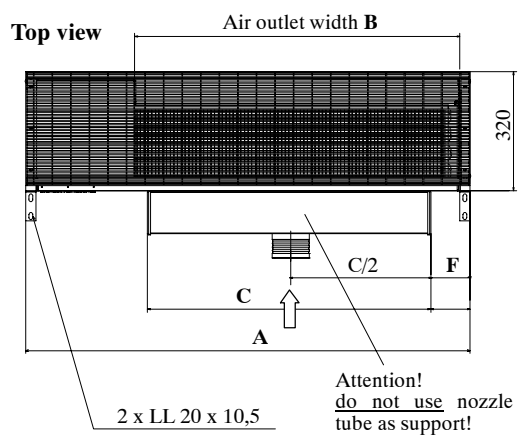
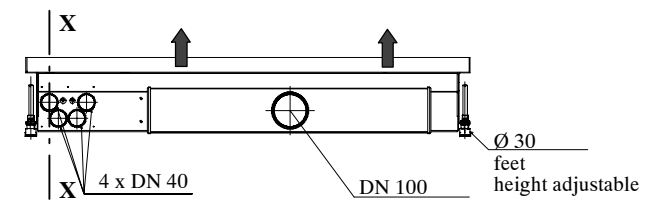

Illustration:
 Version with aluminium grille

Induction unit type HFB-D

Size	A	B	C	F
630	988	626	593	40
800	1198	856	763	95
1000	1398	1056	963	95
1250	1598	1256	1163	95



- ↑ Supply air
- ↓ Room air
- Primary air

Version:	E	H	I	G _{min}
stainless steel grille:	305	44	55	187
aluminium roller grille:	308	48	59	191
aluminium grille:	308	48	59	191

Induction Unit for Installation in Access Floors Type HFB-D Technical Specifications

Size 630

V_P [m ³ /h]	Δp [Pa]	$L_{A18}^{4)}$ [dB(A)]	$L_{wA}^{4)}$ [dB(A)]	$Q_P/\Delta t_P$ [W/K]	$Q_k/\Delta t^{1)}$ [W/K]	$Q_h/\Delta t$ [W/K]	$Q_{EK}^{3)}$ [W]	$w_{ok}/\Delta p_w$ [kg/h]/[kPa]	$w_{oh}/\Delta p_w$ [kg/h]/[kPa]	Q_k^1 [W]	Q_P^2 [W]
35	150	21	27	12	17	10	180	100/1.2	100/1.8	170	120
35	250	22	28	12	20	12				200	120
45	150	24	30	15	21	13				210	150
45	250	26	32	15	26	16				260	150
60	150	26	32	20	28	18				280	200
60	250	28	34	20	33	20				330	200
80	150	28	34	27	32	20				320	270
80	250	33	39	27	36	22				360	270
100	150	31	37	33	34	21				340	330
100	250	33	39	33	39	24				380	330

Size 800

V_P [m ³ /h]	Δp [Pa]	$L_{A18}^{4)}$ [dB(A)]	$L_{wA}^{4)}$ [dB(A)]	$Q_P/\Delta t_P$ [W/K]	$Q_k/\Delta t^{1)}$ [W/K]	$Q_h/\Delta t$ [W/K]	$Q_{EK}^{3)}$ [W]	$w_{ok}/\Delta p_w$ [kg/h]/[kPa]	$w_{oh}/\Delta p_w$ [kg/h]/[kPa]	Q_k^1 [W]	Q_P^2 [W]
45	150	22	28	15	25	15	225	120/2.5	120/3	250	150
45	250	23	29	15	31	19				310	150
60	150	24	30	20	34	20				340	200
60	250	25	31	20	39	24				390	200
80	150	26	32	27	38	23				380	270
80	250	30	36	27	43	26				430	270
100	150	29	35	33	40	25				400	330
100	250	31	37	33	46	28				460	330
120	150	32	38	40	43	26				430	400
120	250	34	40	40	48	29				480	400

- 1) Water supply temperature: 16°C, induction air temperature before entering the heat exchanger: 26°C, non-condensing operation (induction air temperature may vary from ambient air temperature)
- 2) Primary air temperature: 16°C, air inlet temperature: 26°C
- 3) Water supply temperature 70°C, air inlet temperature: 20°C
- 4) Acoustical data for plastic nozzles; aluminium nozzles: sound power level + 3 dB

V_P - primary air flow rate ($\pm 10\%$)

Δp - static pressure of primary air

L_{A18} - sound pressure level at a room absorption of 18 m² Sabine

L_{wA} - sound power level ± 3 dB(A) (with plastic nozzles)

Q_P - cooling capacity primary air

Δt_P - temperature difference between ambient air and primary air

Q_k - secondary cooling capacity (heat exchanger)

Q_h - heating capacity

Δt - temperature difference between induction air temperature before entering the heat exchanger and water supply

Q_{EK} - heating capacity by natural convection

w_{ok} - standard water flow rate (cooling)

w_{oh} - standard water flow rate (heating)

Δp_w - water-side pressure loss

Induction Unit for Installation in Access Floors Type HFB-D Technical Specifications

Size 1000

V _P [m ³ /h]	Δp [Pa]	L _{A18} ⁴⁾ [dB(A)]	L _{wA} ⁴⁾ [dB(A)]	Q _P /Δt _P [W/K]	Q _k /Δt ¹⁾ [W/K]	Q _h /Δt [W/K]	Q _{EK} ³⁾ [W]	w _{ok} /Δp _w [kg/h]/[kPa]	w _{oh} /Δp _w [kg/h]/[kPa]	Q _k ¹ [W]	Q _P ² [W]
60	150	22	28	20	40	24	280	150/4	150/4.6	400	200
60	250	24	30	20	47	28				470	200
80	150	26	32	27	46	27				460	270
80	250	29	35	27	52	31				510	270
100	150	28	34	33	50	30				500	330
100	250	31	37	33	55	33				550	330
120	150	30	36	40	53	32				530	400
120	250	33	39	40	58	35				580	400
140*	150	32	38	47	56	33				560	470
140*	250	35	41	47	60	36				600	470

Size 1250

V _P [m ³ /h]	Δp [Pa]	L _{A18} ⁴⁾ [dB(A)]	L _{wA} ⁴⁾ [dB(A)]	Q _P /Δt _P [W/K]	Q _k /Δt ¹⁾ [W/K]	Q _h /Δt [W/K]	Q _{EK} ³⁾ [W]	w _{ok} /Δp _w [kg/h]/[kPa]	w _{oh} /Δp _w [kg/h]/[kPa]	Q _k ¹ [W]	Q _P ² [W]
80	150	25	31	27	53	32	345	180/5.8	180/7.5	530	270
80	250	28	34	27	58	35				580	270
100	150	27	33	33	57	34				570	330
100	250	30	36	33	61	37				610	330
120	150	30	36	40	62	38				620	400
120	250	32	38	40	67	41				670	400
140*	150	31	37	47	68	42				680	470
140*	250	34	40	47	71	44				710	470
160*	150	35	40	53	73	45				730	530
160*	250	36	43	53	76	47				760	530

1) Water supply temperature: 16°C, induction air temperature before entering the heat exchanger: 26°C, non-condensing operation (induction air temperature may vary from ambient air temperature)

2) Primary air temperature: 16°C, air inlet temperature: 26°C

3) Water supply temperature 70°C, air inlet temperature: 20°C

4) Acoustical data for plastic nozzles; aluminium nozzles: sound power level + 3 dB

* for acoustic reasons, large flow rates will require 2 primary air sockets

V_P - primary air flow rate (± 10%)

Δp - static pressure of primary air

L_{A18} - sound pressure level at a room absorption of 18 m² Sabine

L_{wA} - sound power level ± 3 dB(A) (with plastic nozzles)

Q_P - cooling capacity primary air

Δt_P - temperature difference between ambient air and primary air

Q_k - secondary cooling capacity (heat exchanger)

Q_h - heating capacity

Δt - temperature difference between induction air temperature before entering the heat exchanger and water supply

Q_{EK} - heating capacity by natural convection

w_{ok} - standard water flow rate (cooling)

w_{oh} - standard water flow rate (heating)

Δp_w - water-side pressure loss

Induction Unit for Installation in Access Floors Type HFB-D Selection

Induction unit type HFB-D (4-pipe) cooling coil

Water-side pressure loss and cooling capacity with different flow rates

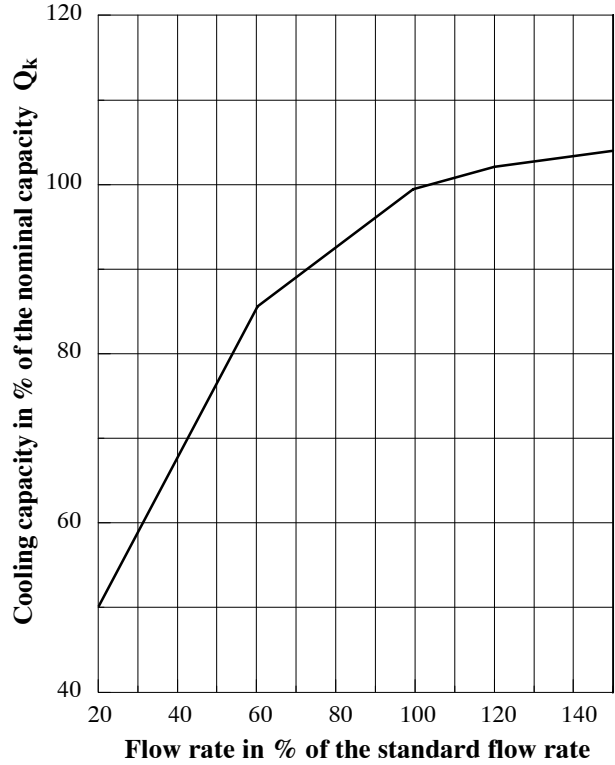
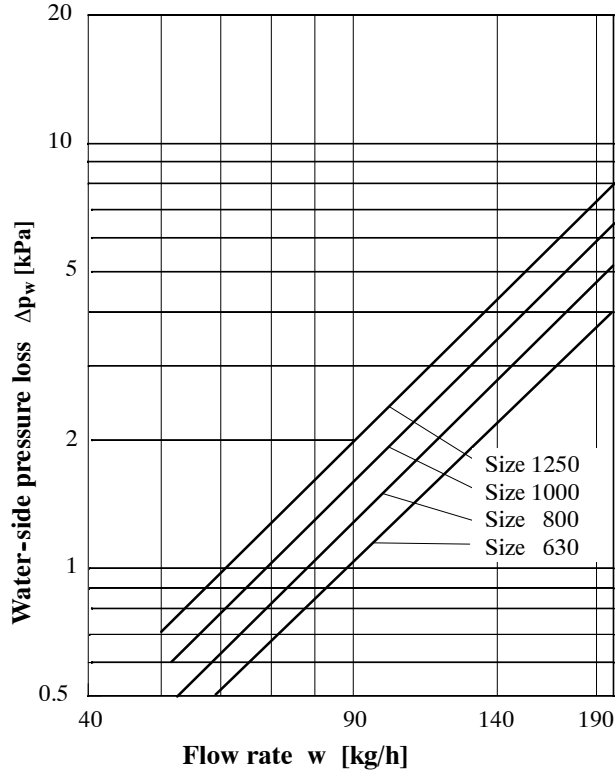

Induction unit type HFB-D (4-pipe) heating coil

Water-side pressure loss and heating capacity with different flow rates

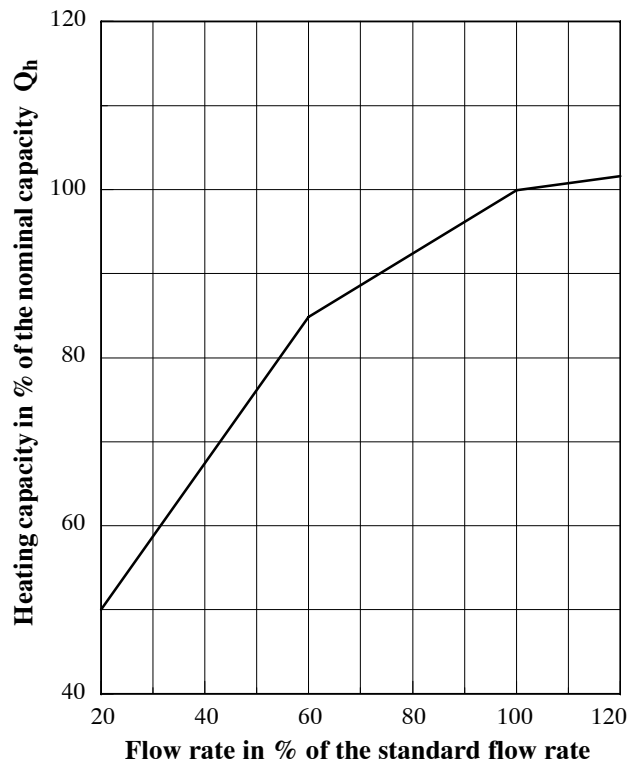
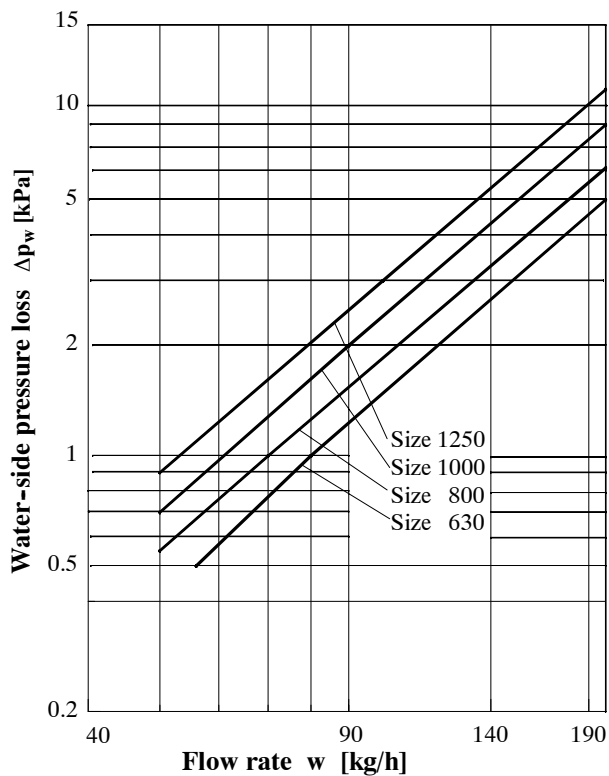

Induction Unit for Installation in Access Floors Type HFB-Z Dimensions

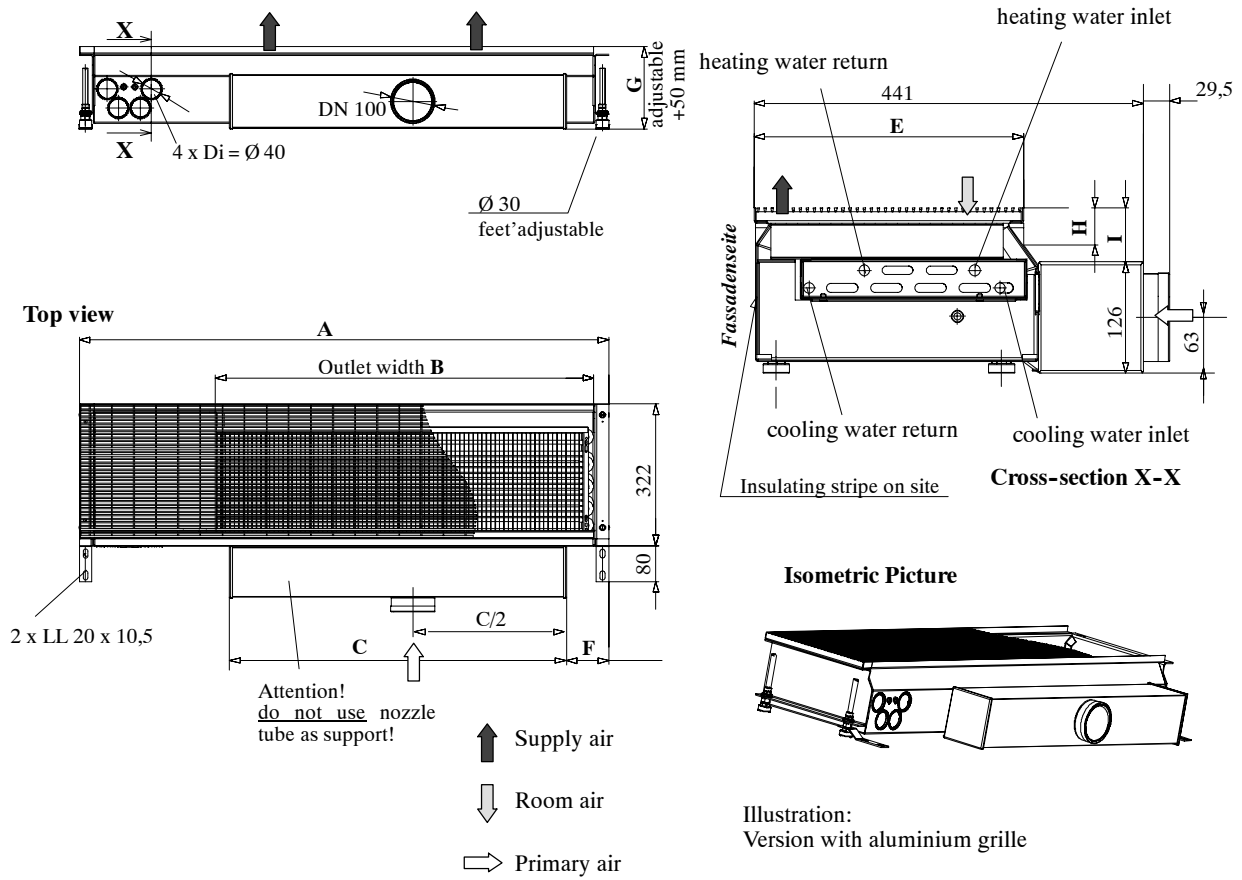

Induction unit type HFB-Z

Size	A	B	C	F
630	988	626	593	40
800	1198	856	763	95
1000	1398	1056	963	95
1250	1598	1256	1163	95

Version:	E	H	I	G _{min}
stainless steel grille:	305	44	55	187
aluminium roller grille:	308	48	59	191
aluminium grille:	308	48	59	191

Induction Unit for Installation in Access Floors Type HFB-Z Technical Specifications

Size 630

V _P [m ³ /h]	Δp [Pa]	L _{A18} ⁴⁾ [dB(A)]	L _{wA} ⁴⁾ [dB(A)]	Q _P /Δt _P [W/K]	Q _k /Δt ¹⁾ [W/K]	Q _h /Δt [W/K]	Q _{EK} ³⁾ [W]	w _{ok} /Δp _w [kg/h]/[kPa]	w _{oh} /Δp _w [kg/h]/[kPa]	Q _k ¹ [W]	Q _P ² [W]
35	150	< 22	< 28	12	16	13	165	100/3	100/2	160	120
35	250	< 22	< 28	12	18	15				180	120
45	150	< 22	26	15	17	15				170	150
45	250	23	29	15	20	17				200	150
60	150	24	30	20	22	19				220	200
60	250	27	33	20	25	21				250	200
80	150	28	34	27	29	25				290	270
80	250	30	36	27	33	28				330	270
100	150	33	39	33	35	30				350	330
100	250	35	41	33	39	34				390	330

Size 800

V _P [m ³ /h]	Δp [Pa]	L _{A18} ⁴⁾ [dB(A)]	L _{wA} ⁴⁾ [dB(A)]	Q _P /Δt _P [W/K]	Q _k /Δt ¹⁾ [W/K]	Q _h /Δt [W/K]	Q _{EK} ³⁾ [W]	w _{ok} /Δp _w [kg/h]/[kPa]	w _{oh} /Δp _w [kg/h]/[kPa]	Q _k ¹ [W]	Q _P ² [W]
45	150	< 20	23	15	19	16	210	120/5	120/3,3	190	150
45	250	< 20	25	15	23	19				230	150
60	150	< 20	25	20	25	21				250	200
60	250	22	28	20	29	25				290	200
80	150	23	29	27	33	28				330	270
80	250	27	33	27	38	32				380	270
100	150	28	34	33	40	34				400	330
100	250	31	37	33	45	38				450	330
120	150	32	38	40	47	39				470	400
120	250	35	41	40	53	45				530	400

1) Water supply temperature: 16°C, induction air temperature before entering the heat exchanger: 26°C, non-condensing operation (induction air temperature may vary from ambient air temperature)

2) Primary air temperature: 16°C, air inlet temperature: 26°C

3) Water supply temperature 70°C, air inlet temperature: 20°C

4) Acoustical data for plastic nozzles; aluminium nozzles: sound power level + 3 dB

V_P - primary air flow rate (± 10%)

Δp - static pressure of primary air

L_{A18} - sound pressure level at a room absorption of 18 m² Sabine

L_{wA} - sound power level ± 3 dB(A) (with plastic nozzles)

Q_P - cooling capacity primary air

Δt_P - temperature difference between ambient air and primary air

Q_k - secondary cooling capacity (heat exchanger)

Q_h - heating capacity

Δt - temperature difference between induction air temperature before entering the heat exchanger and water supply

Q_{EK} - heating capacity by natural convection

w_{ok} - standard water flow rate (cooling)

w_{oh} - standard water flow rate (heating)

Δp_w - water-side pressure loss

Induction Unit for Installation in Access Floors Type HFB-Z Technical Specifications

Size 1000

V_p [m ³ /h]	Δp [Pa]	$L_{A18}^{4)}$ [dB(A)]	$L_{wA}^{4)}$ [dB(A)]	$Q_p/\Delta t_p$ [W/K]	$Q_k/\Delta t^{1)}$ [W/K]	$Q_h/\Delta t$ [W/K]	$Q_{EK}^{3)}$ [W]	$w_{ok}/\Delta p_w$ [kg/h]/[kPa]	$w_{oh}/\Delta p_w$ [kg/h]/[kPa]	Q_k^1 [W]	Q_p^2 [W]
60	150	21	27	20	34	28	260	150/10	150/6	340	200
60	250	23	29	20	39	33				390	200
80	150	23	29	27	38	32				380	270
80	250	26	32	27	44	37				440	270
100	150	28	34	33	43	36				430	330
100	250	30	36	33	49	41				490	330
120	150	32	38	40	47	39				470	400
120	250	34	40	40	54	45				540	400
140*	150	35	41	47	51	43				510	470
140*	250	37	43	47	58	49				580	470

Size 1250

V_p [m ³ /h]	Δp [Pa]	$L_{A18}^{4)}$ [dB(A)]	$L_{wA}^{4)}$ [dB(A)]	$Q_p/\Delta t_p$ [W/K]	$Q_k/\Delta t^{1)}$ [W/K]	$Q_h/\Delta t$ [W/K]	$Q_{EK}^{3)}$ [W]	$w_{ok}/\Delta p_w$ [kg/h]/[kPa]	$w_{oh}/\Delta p_w$ [kg/h]/[kPa]	Q_k^1 [W]	Q_p^2 [W]
80	150	22	28	27	45	36	325	180/16	180/10	450	270
80	250	25	31	27	51	43				510	270
100	150	24	30	33	52	44				520	330
100	250	27	33	33	59	50				590	330
120	150	28	34	40	56	47				560	400
120	250	31	37	40	63	53				630	400
140*	150	32	38	47	60	51				600	470
140*	250	35	41	47	68	58				680	470
160*	150	35	41	53	65	55				650	530
160*	250	38	44	53	73	62				730	530

1) Water supply temperature: 16°C, induction air temperature before entering the heat exchanger: 26°C, non-condensing operation (induction air temperature may vary from ambient air temperature)

2) Primary air temperature: 16°C, air inlet temperature: 26°C

3) Water supply temperature 70°C, air inlet temperature: 20°C

4) Acoustical data for plastic nozzles; aluminium nozzles: sound power level + 3 dB

* bei großer Luftmenge aus akustischen Gründen 2 Primärluftstutzen erforderlich

V_p - primary air flow rate ($\pm 10\%$)

Δp - static pressure of primary air

L_{A18} - sound pressure level at a room absorption of 18 m² Sabine

L_{wA} - sound power level ± 3 dB(A) (with plastic nozzles)

Q_p - cooling capacity primary air

Δt_p - temperature difference between ambient air and primary air

Q_k - secondary cooling capacity (heat exchanger)

Q_h - heating capacity

Δt - temperature difference between induction air temperature before entering the heat exchanger and water supply

Q_{EK} - heating capacity by natural convection

w_{ok} - standard water flow rate (cooling)

w_{oh} - standard water flow rate (heating)

Δp_w - water-side pressure loss

Induction Unit for Installation in Access Floors Type HFB-Z Selection

Induction unit type HFB-Z (4-pipe) cooling coil Water-side pressure loss and cooling capacity with different flow rates

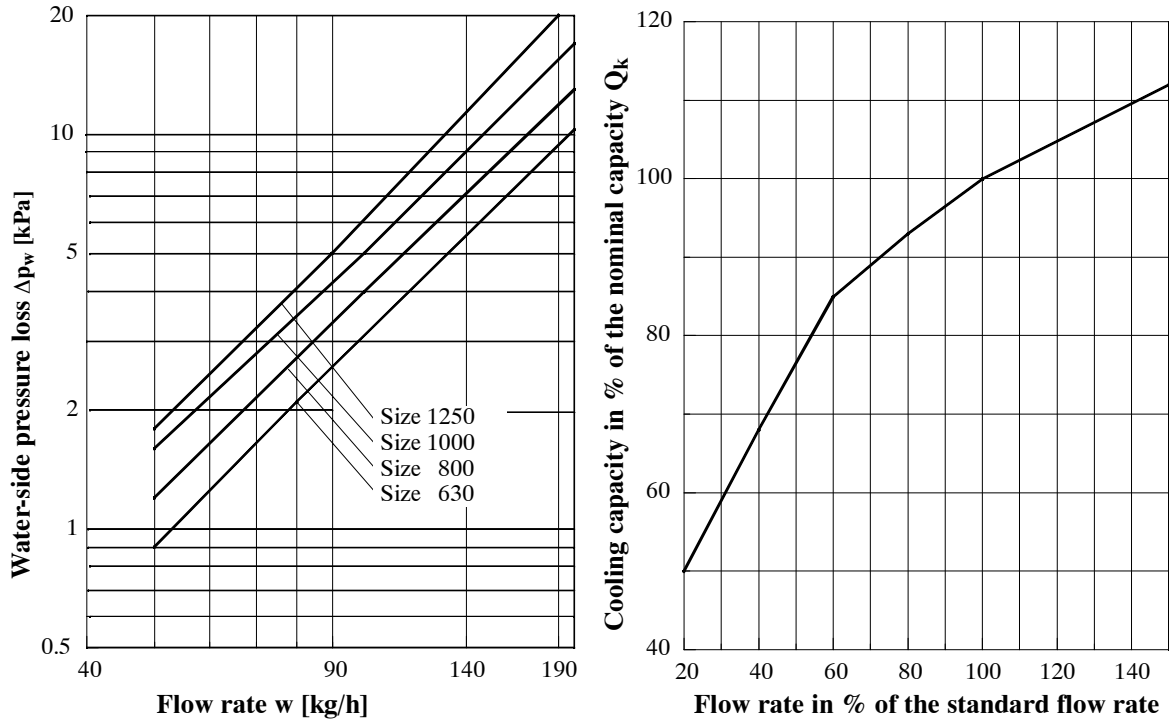

Induction unit type HFB-Z (4-pipe) heating coil Water-side pressure loss and heating capacity with different flow rates

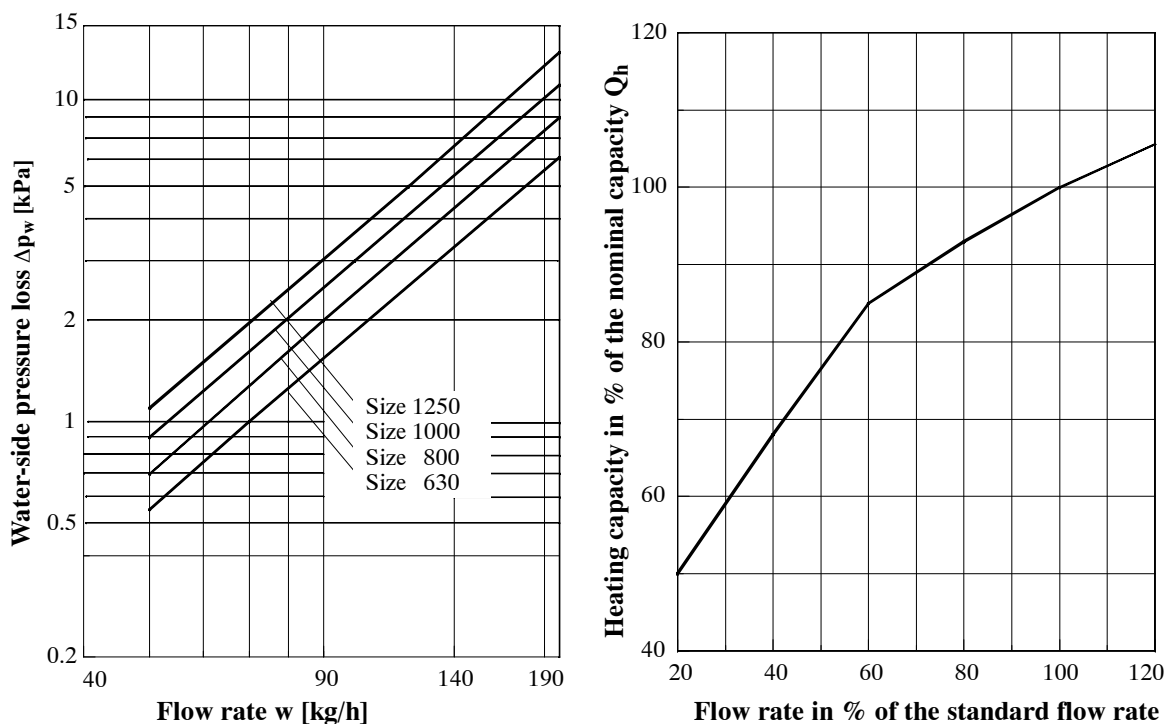

Induction Unit for Installation in Access Floors Type HFB

Installation

The compact design allows for installation of the unit between floor supports. Height-adjustable feet ensure a precise alignment of the unit.

For air connection use one of the two connecting sockets on the unit's backside. The control valve compartment and the water connection are located on the unit's left side. Bushings for water connection hoses are provided on the unit's rear panel, on the left hand side.

The ventilation grille is designed to be flush-mounted to the floor. It is foot traffic resistant without the need for any additional cross members.

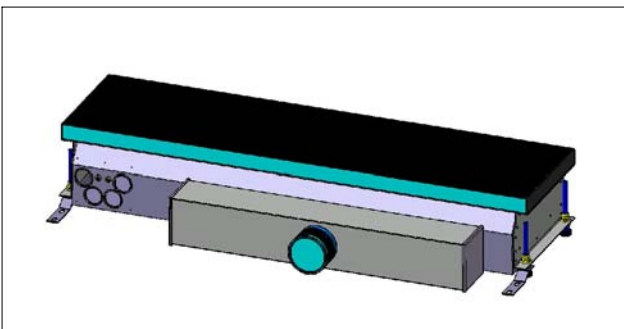

Induction Unit Type HFB - with ventilation grille

Installation Sequence

- Set the unit with insulating strips directly on the facade.
- Height adjustment and exact positioning of the unit through adjustable feet.

- If required, use e.g. a PU adhesive to fix the unit feet in order to avoid accidental movement.
- Adjustment via damper blade and pressure measurement.
- Set the feet for floor panels and install the floor panels so that a direct contact with the unit is ensured.
- Complete electrical and water connections. Water connections must be flexible and strainless.

Special Versions / Accessories

- Control valves optionally with continuous, thermal or 3-position actuator.
- Insulated flexible hoses with safe quick-release connectors on the heat exchanger and integrated air-relief valves.
- Solid, foot traffic resistant ventilation grille not requiring any additional cross members, with blades parallel to the facade. Aluminum or stainless steel, inserted into the floor pan from above. The use of grilles of other manufacturers requires LTG permission in order to ensure a proper function of the entire system.
- Primary air flow damper for air flow balancing to obtain a ratio of up to about 1:1.5.

Control

Water-side control through control valves.

Maintenance

All components are located within a sheet steel pan and are easily accessible from above for maintenance, inspection and cleaning.

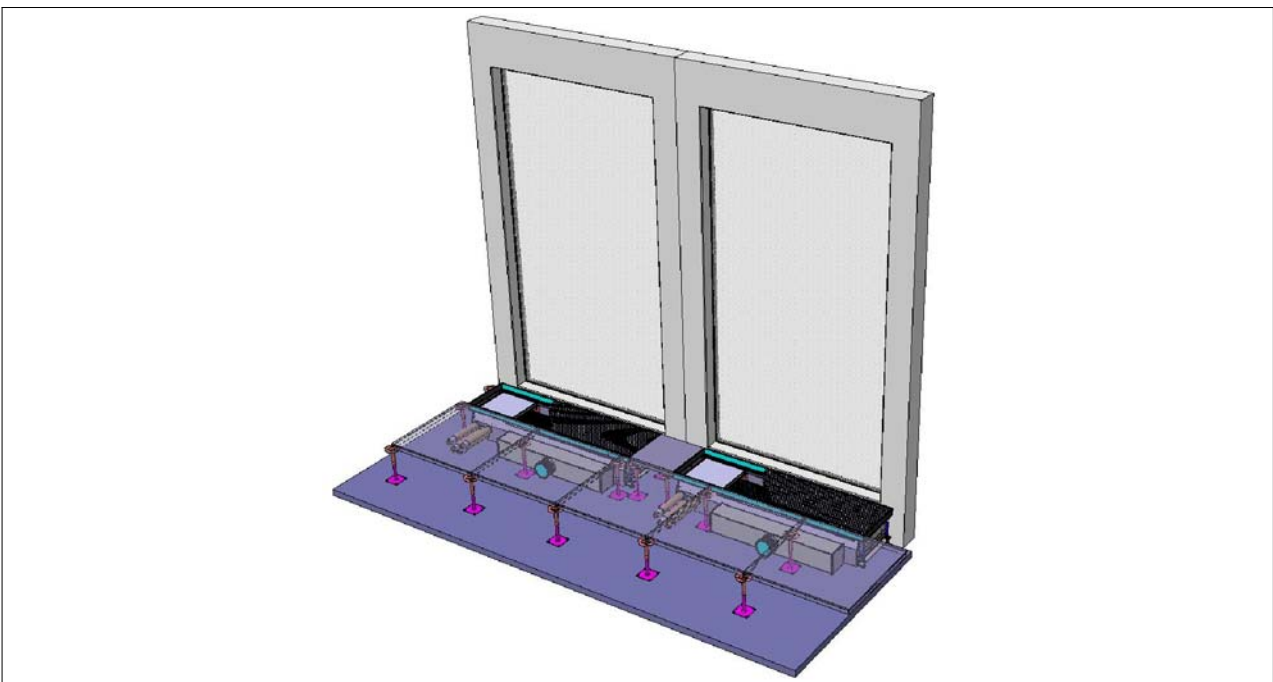

Induction Unit Type HFB - Installation between floor supports

Induction Unit for Installation in Access Floors Type HFB-N, HFB Installation example

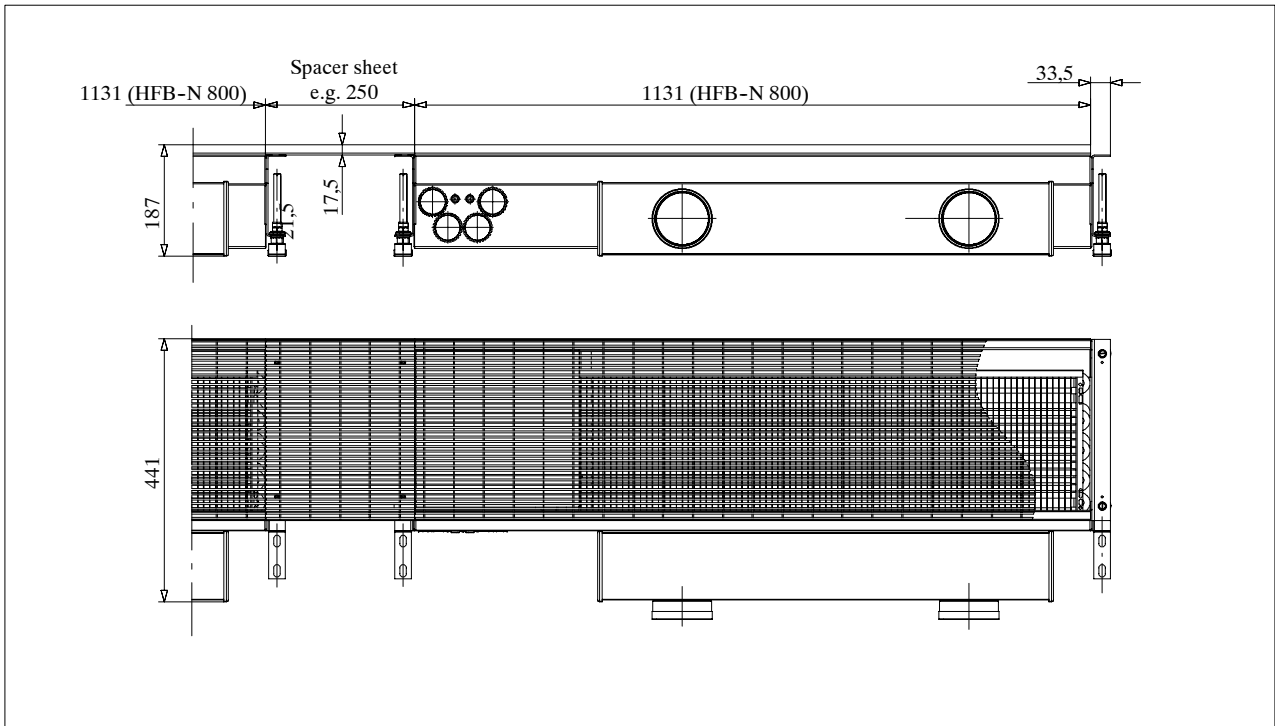

Installation example: continuous grille on the facade

Installation in line

In order to produce a "continuous effect" grille, black coated spacer sheets are fixed between the units.

If the space between units is greater than 400 mm or if end pieces are used, additional supports will be required to provide more stability.

If the space is 600 mm or greater, the use of an empty tray is recommended for stabilization.

The LTG roller grilles may also be used to create cutouts for columns or mitre edges.

Grille load capacity

The 3 variants of foot traffic resistant LTG grilles offer the following static load capacities:

- Stainless steel grille 1500 kg/m²
- Aluminium roller grille 1600 kg/m²
- Aluminium linear grille 2000 kg/m²

Other capacities on request



LTG Stainless steel grille



LTG aluminium roller grille

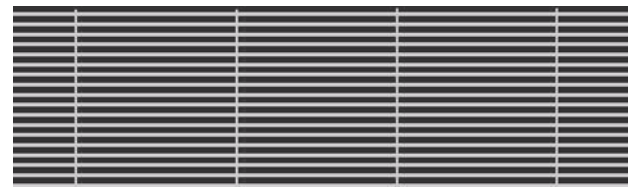

LTG aluminium grille

Induction Unit for Installation in Access Floors Type HFB

Nomenclature

HFB - Z - 2 / 800 / 300 / 1198 / 1R / E / S

two-row heat exchanger	Z						
three-row heat exchanger	D						
2-pipe-unit	2						
4-pipe-unit	4						
size		630					
		800					
		1000					
		1250					
width of grille			300				
				length of unit			
without angular end piece for distance sheet					OR		
1 angular end piece					1R		
2 angular end pieces					2R		
grille stainless steel						E	
aluminum roller grille20 mm						AR	
anodized aluminum						AE	
				coating black			S
				coating special colour			SO

Specification and Schedule of Prices

Induction Unit for Installation in False Floors Type HFB

Edition 10.7.2008 / page 1

Qty.	Description	Unit price in €	Total price in €
	<p style="text-align: center;">Induction unit for 2- and 4-pipe systems for water-side control by valves Type HFB (heating and cooling)</p> <p><u>Induction unit with</u> a multi-row heat exchanger with separate water circuits for cooling and heating (2- and 4-pipe system), <u>consisting of</u>:</p> <ul style="list-style-type: none"> - Housing for free installation in floor cavities or false floors, consisting of a torsion-resistant pan of galvanized sheet steel, surface coated, sheet steel thickness: 1.5 mm, with reinforced side edges, sheet thickness 2.5 mm to tolerate high static loads (sound insulation index (RW) > 25 dB), with separate valve housing and supporting profile on the face to accept ventilation grille, including foot traffic sound insulation. - Foot traffic resistant ventilation grille, made of aluminium over the entire unit width, width 300 mm, serving as an inspection opening. Thus, all components are easily accessible from above for maintenance. - Supporting feet, with foot traffic insulation, 4 pieces, height adjustable. - Bushing for water hoses exiting the unit tray in direction of room with edge protection, optimized for high cross-talk attenuation. - Heat exchanger with 2 separate water circuits, consisting of smooth 12 mm copper tubes with pressed-on aluminum fins, for a high caloric output and high natural convection. Operating pressure up to 12 bar. Water-side connection of quick release couplings. - Control valve housing on the unit's left hand side. - Air outlet duct close to the facade for better facade shielding. - Primary air nozzle box with replaceable primary air plastic nozzles, designed for induction with a high level of performance, a low flow noise and a strong reflection of the primary sound. <p>Exterior dimensions (aluminium linear grille): Width x height = 308 (441) mm x 191 mm (dimensions may vary depending on variant)</p> <p>Sizes: o 630 o 800 o 1000 o 1250</p> <p>Manufacturer: LTG Aktiengesellschaft Series: Induction units Type: HFB</p> <p style="text-align: center;">-2-</p>		

Specification and Schedule of Prices

Induction Unit for Installation in False Floors Type HFB

Edition 9.11.2007 / page 2

Qty.	Description	Unit Price in €	Total price in €
	<p>Variants:</p> <ul style="list-style-type: none"> o Damper KLI integrated in the fresh air connection. o Mixed displacement air insert MQ. Spreading vanes to improve indoor air flow, integrated in the discharge section to produce a combined mixed/displacement air flow at low air speed, for increased cooling output and reduced temperature layer formation in the occupied zone. o Stainless steel grille o Aluminum - Roller grille o Prepared for installation in line Differently formed side panel to take a connecting sheet and give the grille a continuous look. <p>Accessories/special version (optional, at extra charge):</p> <ul style="list-style-type: none"> o Flexible hose, oxygen diffusion tight version (Oxiblock, PE), with stainless steel braiding, quick release coupling on one side, other side optional, length: 500 mm, without insulation for hot water up to supply temperatures of 50 °C, operating pressure 10 bar o Flexible hose, oxygen diffusion tight version (Oxiblock, PE), with stainless steel braiding, quick release coupling on one side, other side optional, length: 500 mm, with insulation for cold water <p><u>or standard hose:</u></p> <ul style="list-style-type: none"> o Flexible hose, (EPDM-core), with stainless steel braiding, quick release coupling on one side, other side optional, length: 500 mm, without insulation for hot water o Flexible hose, (EPDM-core), with stainless steel braiding, quick release coupling on one side, other side optional, length: 500 mm, with insulation for cold water <ul style="list-style-type: none"> o 2 valves with thermoelectrical actuator o 2 valves with 3-position actuator o Plug-in connections with 1/2" internal thread for direct valve connection 		

Specification and Schedule of Prices

Induction Unit for Installation in False Floors Type HFB

Edition 9.11.2007 / page 3

Technical Specification

Primary air pressure	[Pa]
Primary air flow rate	[m ³ /h]
Sound power L _{WA}	[dB(A)]
Sound pressure level at 18 m ² Sabine L _{pA}	[dB(A)]

Cooling mode

Induction air temperature	[°C]	<input type="text"/>
Primary air temperature	[°C]	<input type="text"/>
Water supply temperature	[°C]	<input type="text"/>
Cooling capacity	[W]	<input type="text"/>

Heating mode

Induction air temperature	[°C]	<input type="text"/>
Water supply temperature	[°C]	<input type="text"/>
Heating capacity	[W]	<input type="text"/>
Natural convection	[W]	<input type="text"/>